

EQUIPMENT CATALOG

*Simplex Manifold
For 3000 psig Cylinders*

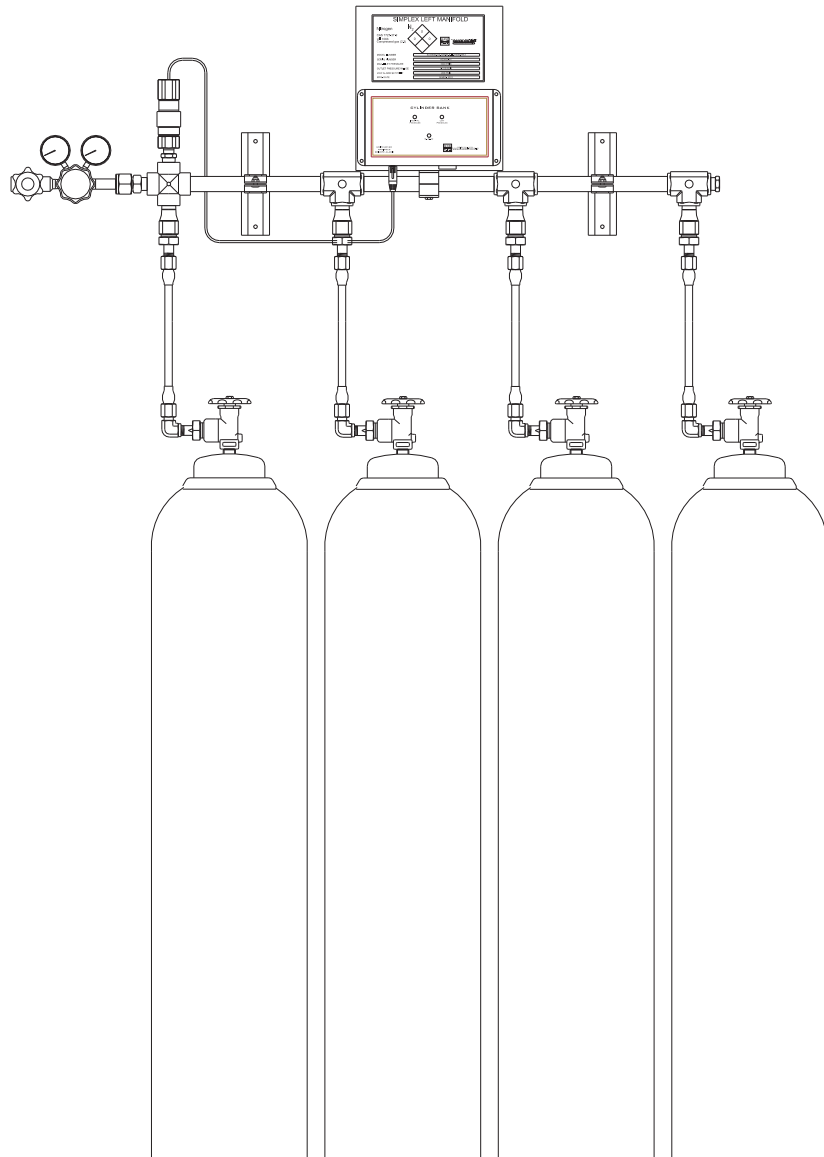

*Helping our customers
to become more effective*

Model shown:
Simplex Left Manifold
SLM3000-O2-125-B1-3-N-NH-RA1

**OPTIONAL
ALARM BOX**

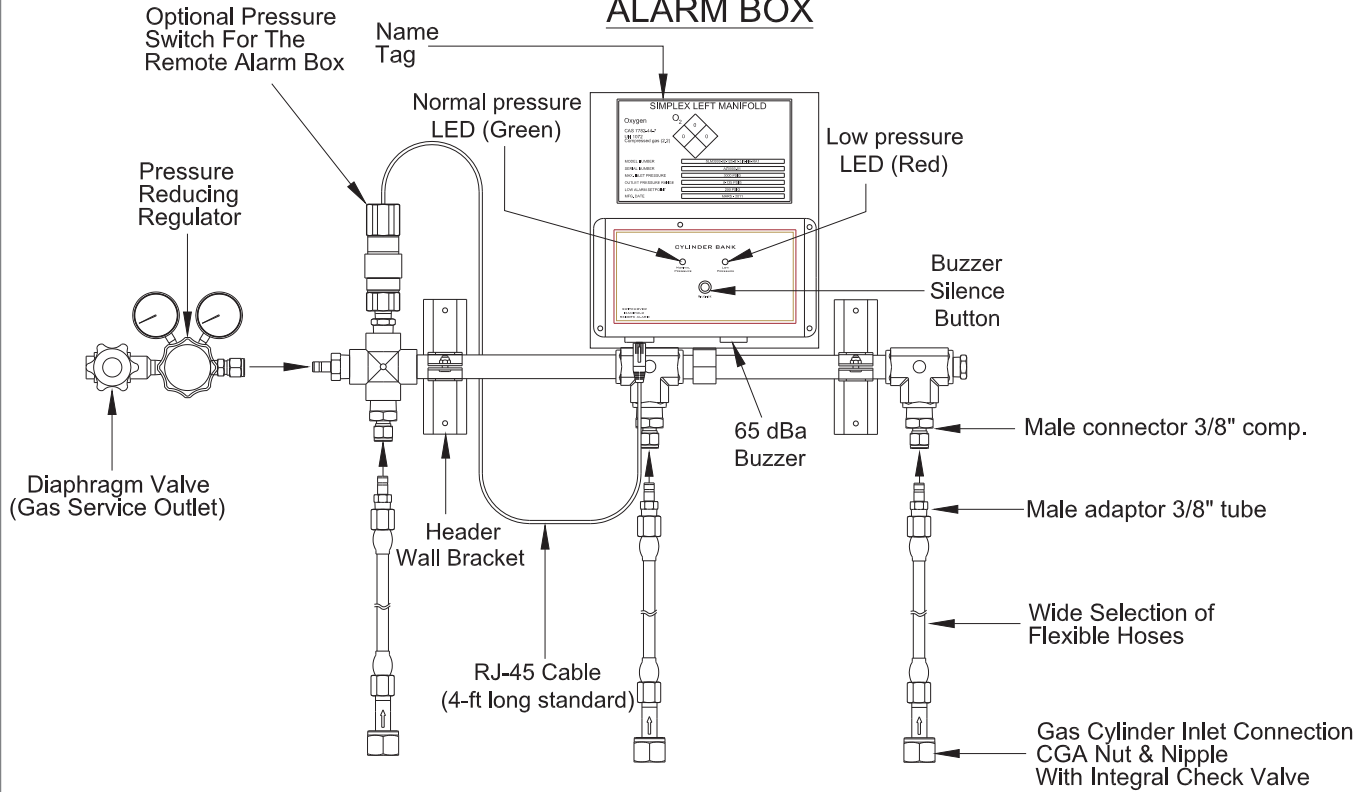

Model shown:
Simplex Center Manifold
SCM3000-O2-125-B1-2-2-N-NH-VV

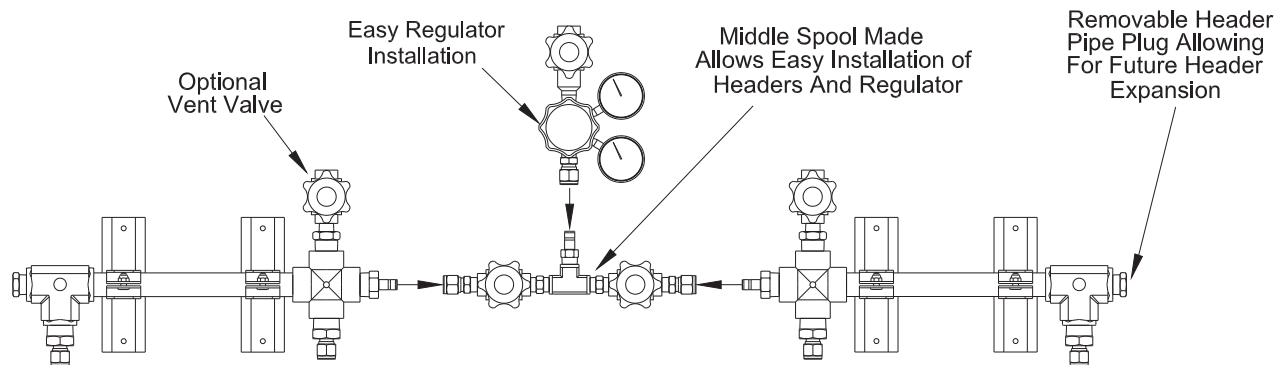

HOW TO ORDER - PART NUMBER MATRIX

SIMPLEX LEFT MANIFOLDS

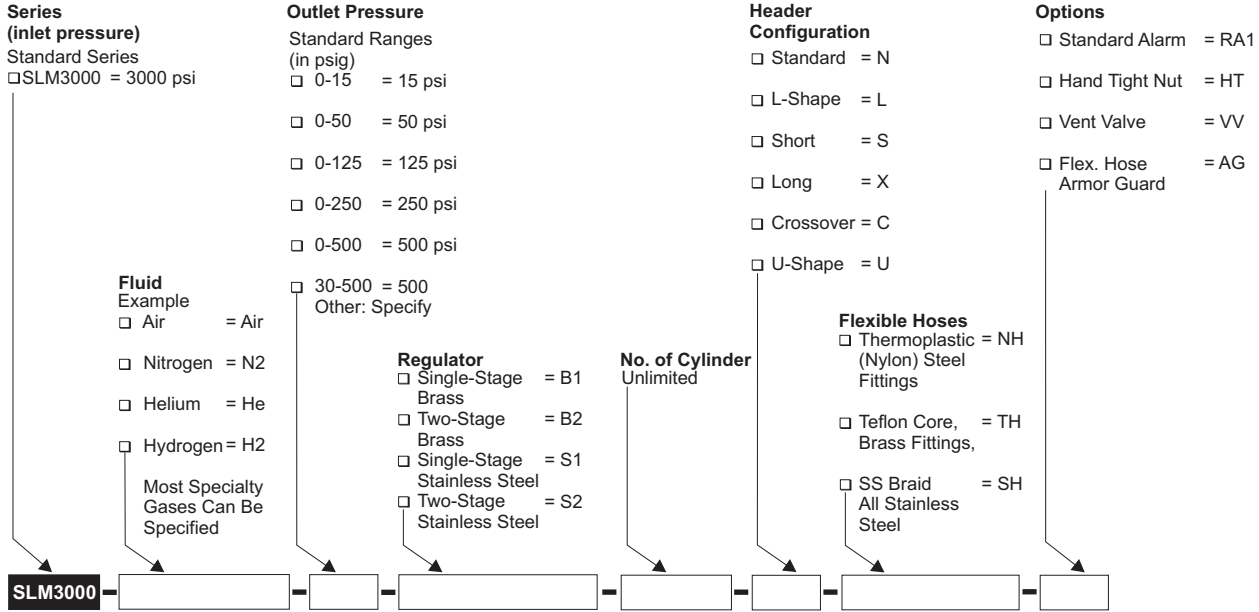

WHEN A STAINLESS STEEL REGULATOR IS SELECTED, ALL FITTINGS, GAUGES AND PRESSURE SWITCHES COME AUTOMATICALLY IN STAINLESS STEEL

SIMPLEX CENTER MANIFOLDS

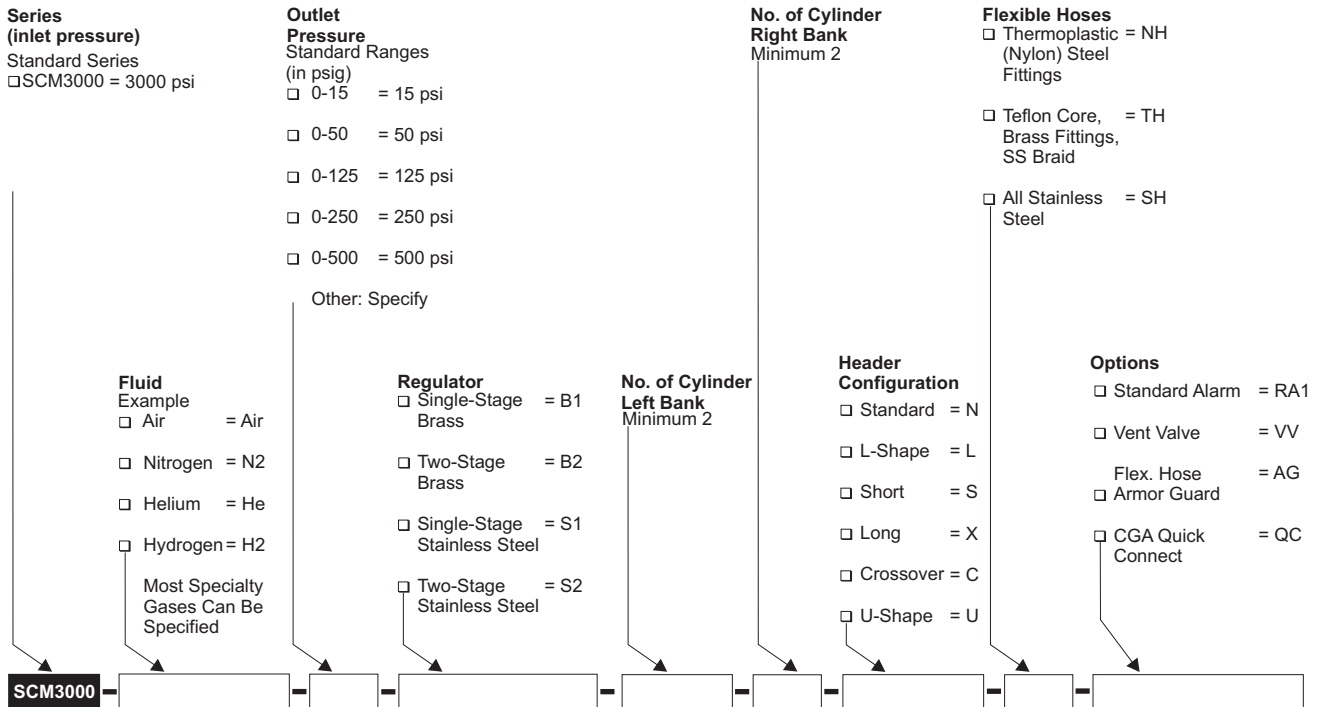

WHEN STAINLESS STEEL REGULATORS ARE SELECTED, ALL FITTINGS, GAUGES AND PRESSURE SWITCHES ARE AUTOMATICALLY SUPPLIED IN STAINLESS STEEL

DIMENSIONAL DRAWING

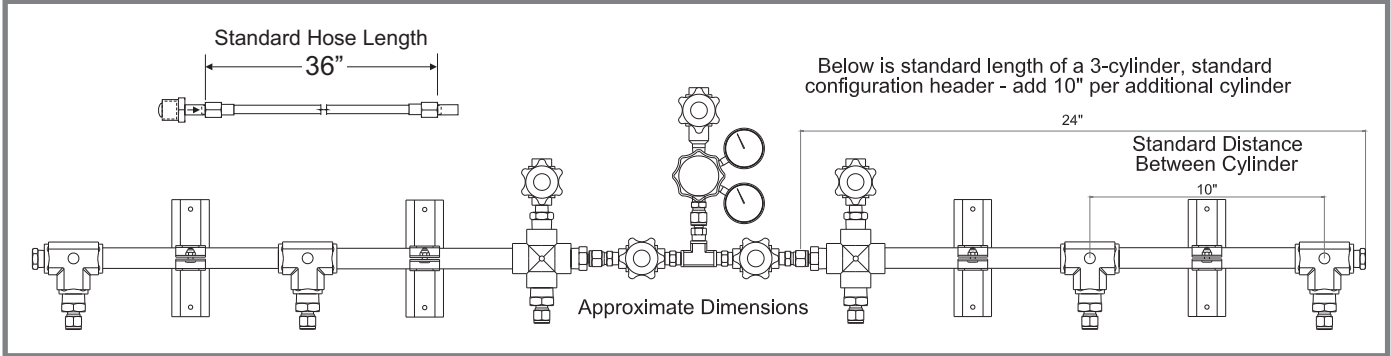

FLOW SCHEMATIC

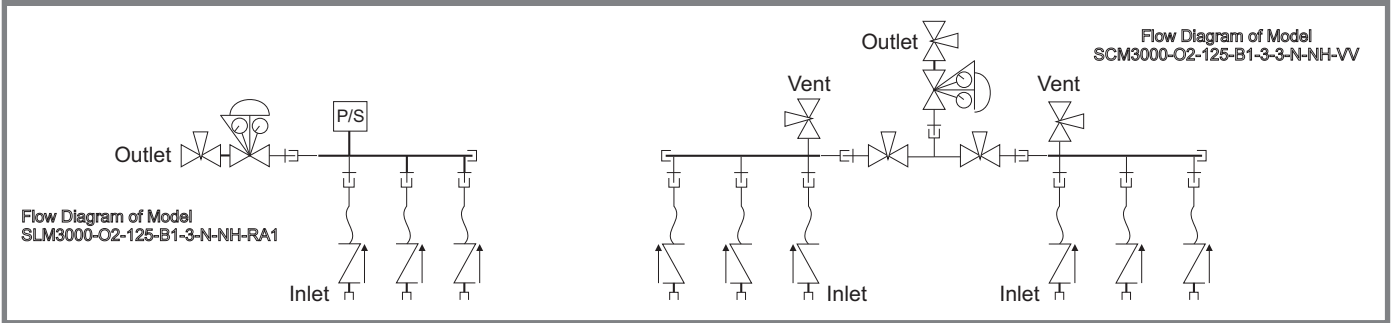

STANDARD SPECIFICATIONS AND MATERIALS OF CONSTRUCTION

Model	SM3000 Series Brass construction	SM3000 Series All stainless steel construction
Maximum inlet pressure	3000 psig	3000 psig
Outlet pressure range	See part number matrix	See part number matrix
Inlet connection fitting	Gas related brass CGA nut & nipple	Gas related type 316 stainless steel CGA nut & nipple
Gas service outlet connection	1/4" F.NPT	1/4" F.NPT
Vent valve outlet connection	1/4" M.NPT	1/4" M.NPT
Operating temperature	-40°F to 140°F	-40°F to 140°F
Pressure gauge dial & material	2"-dial, brass	2"-dial, type 316 stainless steel
Fitting size & material	1/4" NPS, brass	1/4" NPS, type 316 stainless steel
Pressure regulator		
Body	Brass bar stock	Type 316L stainless steel bar stock
Diaphragm	Type 304 stainless steel	Type 316L stainless steel
Filter	10-micron Nickel-plated sintered bronze	40-micron Type 316L stainless steel
Seats	PCTFE	PCTFE
Seals	Teflon	Teflon
Vent & isolation valves		
Body	Forged brass UNS 37700	Type 316 stainless steel
Seats	Nylon, Zytel 101 or Celanese 1000-1	PFA
Seals	Virgin Teflon	PFA